

LIFT KING

Goliath 10,000 LB Doublewide

Manual

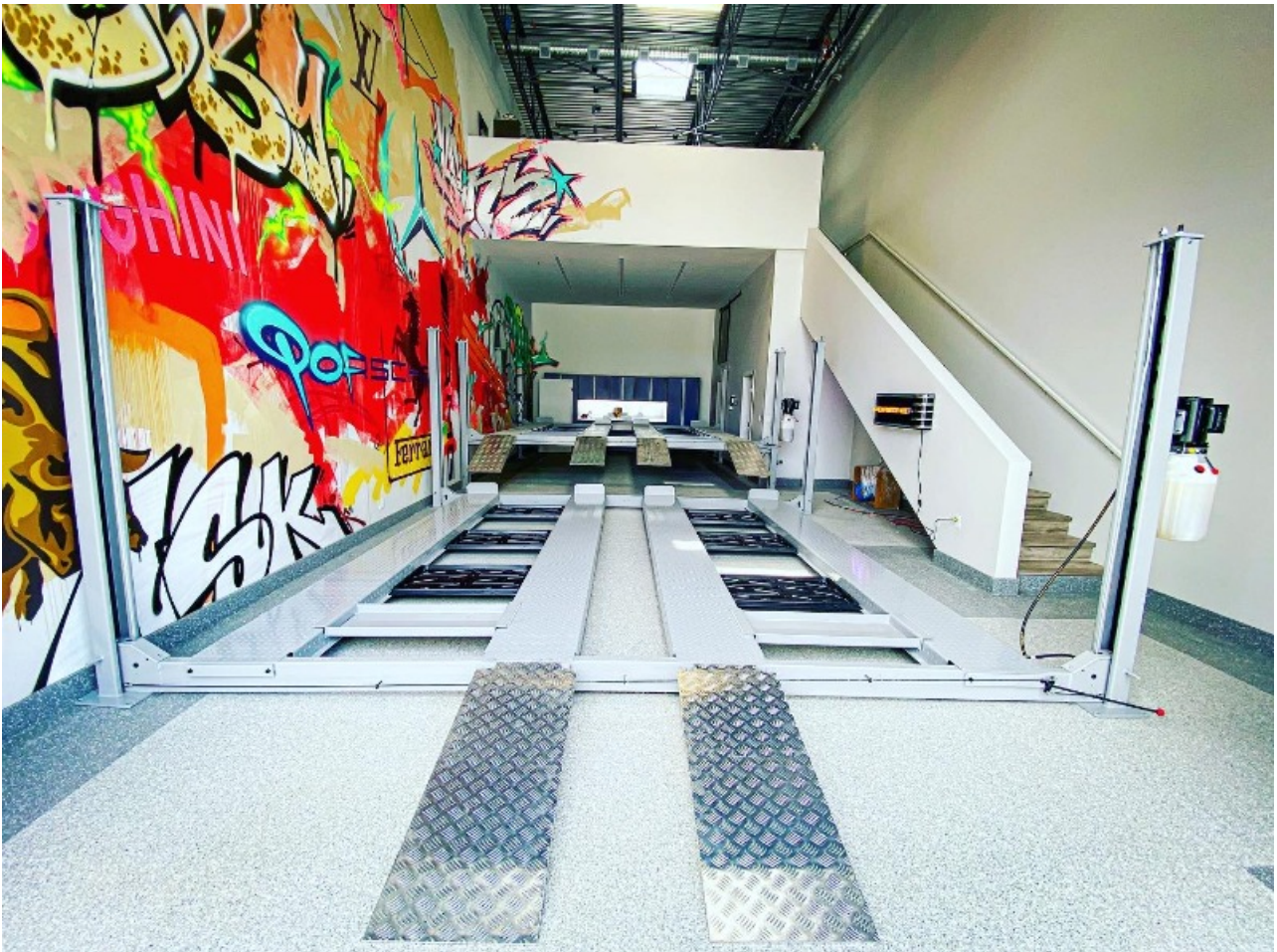

Contents

1 Safety instruction and attentions.....	3
1.1 Cautions with words.....	3
1.2 Safety caution signal.....	4
1.3 Using Purpose.....	5
1.4 Expected Rated Lifted Assignment	6
1.5 Attentions.....	6
2 Introduction on Main Parts of the Lift.....	7
3 Main parameters of the equipment.....	7
3.1 Outside Dimension Picture.....	7
3.2 Lift parameter chart.....	8
4 Installation and operation of the equipment.....	8
4.1 Installation.....	8
4.2 Operation.....	11
5. Checking Points before Using.....	12
5.1 General Checking Points.....	12
6 Packing, transport and storage.....	13
7 Trouble Shooting.....	13
8 Hydraulic diagram.....	14
10 spare parts list.....	15

1 Safety instruction and attentions

Failure to read these instructions may result in injury to user, and other people within the area of the lift, or vehicles. We are not responsible for any injury or damage as a result of not carefully read and follow these instructions.

Always lock the lift in place before going under the vehicle. Never allow anyone to go under the lift when raising or lowering.

INSPECT your lift daily. Never operate if it malfunctions or if it has broken or damaged parts. Repairs should be made with original equipment parts.

ATTENTION! LOOK OUT!

1.1 Cautions with words



Pay special attention to the parts connected with product safety. Here are some examples:

If there is this signal before any passage, it means that operation like this is wrong and will lead to big casualty or heavy damage to the device.





The figure appearing before passage shows that it is not allowed to operate according to the passage, or the potential risk will develop into big casualty and heavy damage to the lift.





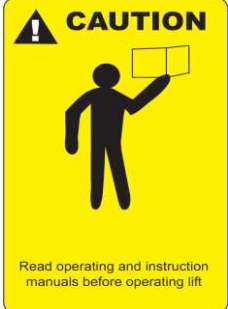
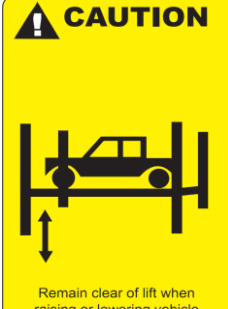

The passage besides this signal lists the notice points and security requirements during the process of normally using, maintenance and care of the lift.

1.2 Safety caution signal

Please read Safety Signage carefully, understand and remember them.

 <p>CAUTION</p> <p>Routine maintenance and inspection is necessary for safe lift operation</p>	<p>Routine maintenance and inspection is necessary for safe lift operation</p>
 <p>CAUTION</p> <p>Read operating and instruction manuals before operating lift</p>	<p>Read operating and instruction manuals before operating lift</p>
 <p>CAUTION</p> <p>Remain clear of lift when raising or lowering vehicle</p>	<p>Remain clear of lift when raising or lowering vehicle</p>
 <p>CAUTION</p> <p>Clear area if vehicle is in danger of falling</p>	<p>Clear area if vehicle is in danger of falling</p>
 <p>CAUTION</p> <p>Keep feet clear of lift whilst lowering vehicles</p>	<p>Keep feet clear of lift whilst lowering vehicles</p>

	<p>Only authorized personnel in lift vicinity</p>
	<p>Lift only to be used by trained personnel</p>
	<p>Do not operate damaged lift</p>
	<p>Do not exceed lifting capacity</p>
	<p>Avoid excessive rocking of vehicle while on lift</p>

1.3 Using Purpose

The lift is used to parking the car whose weight is less than (Routine check of safety latch system is very important - discovery of device failure before using could help you save production time, avoid expensive property damage, serious personal injury and even death.)

1.4 Expected Rated Lifted Assignment

	Rated Load
Goliath 10K Doublewide	4500KG/10,000 LB

In principle, the lift we design supports double direction placement of the car, however, it's better to use the shorter arm to support the motor end, because in this case there will be less wear and tear for the lift

1.5 Attentions

- Operating controls are designed to close when released. Do not block open or override them.
- NEVER overload your lift. Manufacturer's rated capacity is shown on nameplate affixed to the lift. ALWAYS be clear of the gross weight of vehicle.
- NEVER use the lift to raise one end or one side of vehicle.
- NEVER raise vehicle with anyone inside it. No one should be in the lift area during operation.
- ALWAYS keep lift area free of obstructions, grease, oil, trash and other debris. Before lowering lift, be sure tool trays, stands, etc. are removed from under vehicle. Release locking devices before attempting to lower lift.
- Adequate ventilation should be provided when working with internal combustion engines.
- Use only manufacturer's recommended attachments.
- KEEP HANDS AND FEET CLEAR from any moving parts. Keep feet clear of lift when lowering. Avoid pinch points.
- GUARD AGAINST ELECTRIC SHOCK. This lift must have ground connection during using to protect the operator from electric shock. Never connect the green power cord wire to a live terminal. This is for ground only.
- DANGER! The power unit used on this lift contains high voltage.
- Cut power before performing any electrical repairs. Put plug in a safe distance from power so that it cannot be accidentally plugged in during service.
- WARNING! RISK OF EXPLOSION. This equipment has internal arcing or sparking parts which should not be exposed to flammable vapors. This machine should not be located in a recessed area or below floor level.
- MAINTAIN WITH CARE. Keep lift clean for better and safe performance. Follow manual for proper lubrication and maintenance instructions. Keep

control handles and/or buttons dry, clean and free from grease and oil.

- STAY ALERT. Watch what you are doing. Use common sense. Be aware.
- CHECK FOR DAMAGED PARTS. Check the working condition of moving parts, breakage of parts or any condition that may affect its operation. Do not use lift if any component is broken or damaged.
- NEVER remove safety related components from the lift. Do not use lift if safety related components are damaged or missing.
- ALWAYS wear safety glasses. Every day eyeglasses should have impact resistant lenses. They are not safety glasses.

READ AND UNDERSTAND ALL SAFETY WARNINGS & PROCEDURES BEFORE OPERATING LIFT. POST THESE SAFETY TIPS WHERE THEY WILL BE A CONSTANT REMINDER TO YOUR LIFT OPERATOR. FOR SPECIFIC INFORMATION OF THE LIFT, ALWAYS REFER TO THE LIFT MANUFACTURER'S MANUAL.

Improper installation can cause accelerated wear, resulting in catastrophic failure such as property damage and body injury. Manufacturer will assume no liability for loss or damage of any kind, caused by not following the operation manual. Read this installation manual thoroughly before attempting to install or operate the lift.

2. Introduction on Main Parts of the Lift

The four post parking lift is the more convenient lift for parking the vehicle. The following words will help you understand the working principle of the device before using. Please read this instruction manual carefully, so it will help you operate and use maintain this device in correct way and prolong its lifespan. **The lift is characterized with its simple and reasonable structure, low noise, and steady rising and lowering. After installation, connect the power to the power unit, the gear begin to work and the hydraulic oil enter the oil cylinder and push the piston rod up, which cause the chain lift the two platforms to rise.** Since the minimum lifting height of the equipment is quite low, this device can be used widely. Because it's convenient to operate, it's used as the necessary maintenance equipment. It's not allowed to lift vehicle whose rated weight is above 4500 KG with this equipment.

3. Main parameters of the equipment

3.1 Outside Dimension Picture

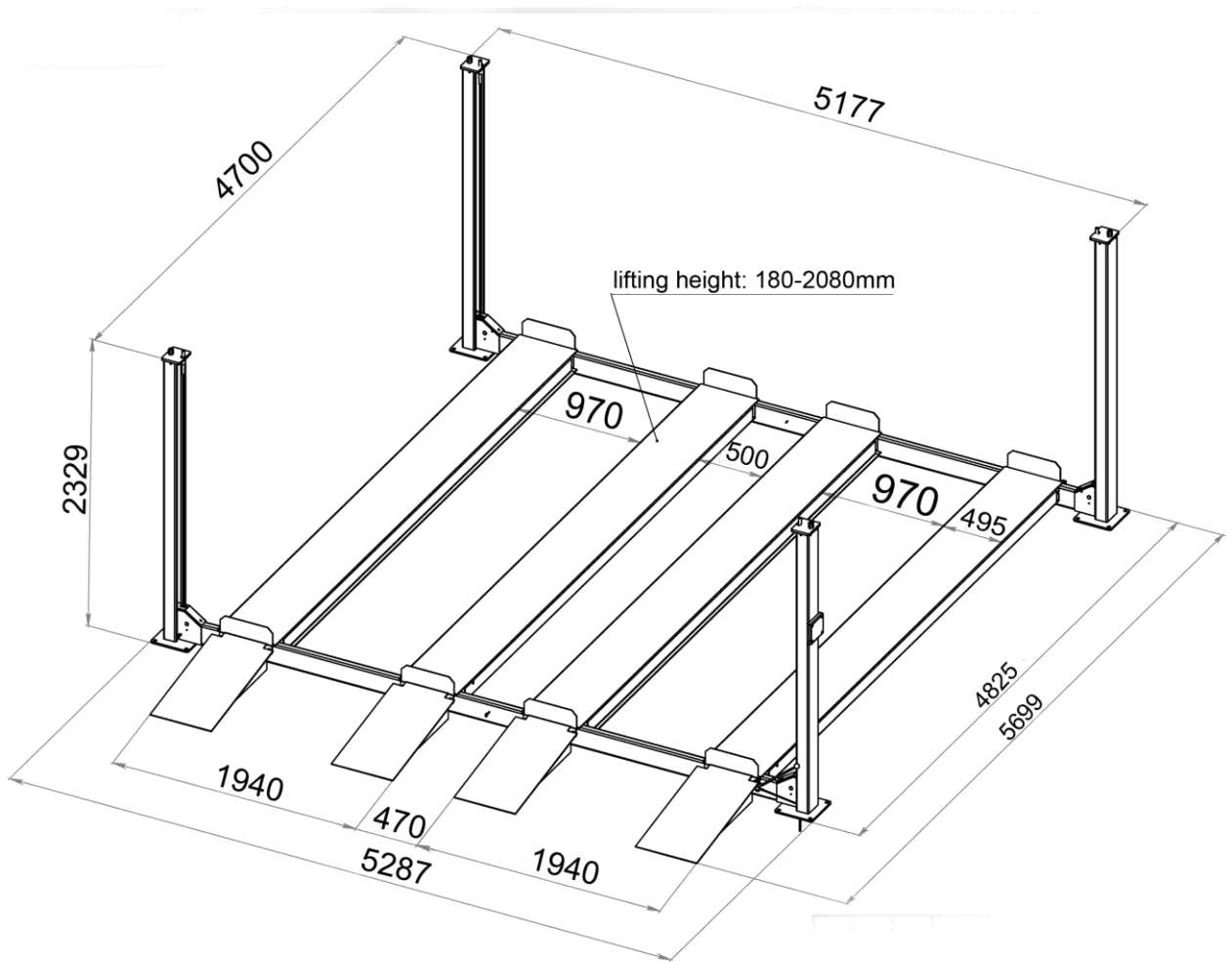

3.2 Lift parameter chart

Total Height	2329mm	
Lifting/Dropping Time	≈50s	
The Maximum Lifting Height	2080mm	
Overall length:	5699mm	
Rated Load	4500 KG /10,000 LB	
Motor Power	2.2kw	
Working Voltage	3~400V+N+PE	1~230V+N+PE
Noise Level	≤70dB(A)	
Oil Pressure	20MPa	

4 Installation of the equipment

4.1 Installation

SELECTING SITE: Before installing your new lift, check the following points.

OVERHEAD OBSTRUCTIONS: The area where the lift will be located should be free of overhead obstructions such as heaters, building supports, electrical wires etc.

FLOOR REQUIREMENTS: Visually inspect the site where the lift is to be installed and check if there is cracked or defective concrete. This lift must be installed on a solid level concrete floor with no more than 2 degrees of slope. A level floor is suggested for proper installation and level lifting. If a floor is of questionable slope, consider a survey of the site and the possibility of pouring a new level concrete slab. This lift is designed to be installed on a minimum of 180mm thick, 3500psi, steel reinforced concrete. Do not install this lift on asphalt, wood, or any other surface other than described.

DO NOT install this lift outdoors unless special consideration has been made to protect the power unit from weather conditions. **The Power unit is not water proof!!!**

DO NOT begin installation with lift close to wall. It is necessary to leave adequate clearance for installing safety linkage rods. Allow 1524mm for clearance. **(See pic)**

NOTE The power unit can be placed in two locations, front left or rear right **(See pic)**

Unpacking: Unpack the lift close to the installation site. Review your packing list and assembly drawing to verify that you have all the parts. Layout a chalk line on the floor following the floor plan **(See pic)**

Stand the column in place making sure the power unit mounting bracket at the correct location and the lock blocks facing outward.

TOOLS recommended

"Rotary Hammer Drill or Similar (If Anchoring / Not required) "Medium Crescent Wrench

"φ19" Masonry Bit (If Anchoring / Not required) "Medium Pipe Wrench

"Hammer "Crow Bar"

4 Foot Level "Chalk Line

"Open-End Wrench Set: 12-28 "Medium Flat Screwdriver

"Socket and Ratchet Set: 12 -28 "Tape Measure: 5m Minimum

"Hex-Key / Allen Wrench Set "Needle Nose Pliers

COLUMN & CROSSRAIL INSTALLATION Lay down rear columns. Position the Cross rail at the top of the two columns. (Both cross rails are the same) Install the Cross rail in the column by sliding the plastic guide blocks into the column channel. The safety latch must be positioned in the same level from the ground, and make safety latch facing towards the outside of the lift when you stand the columns back up. Manually open the safety latch devise on each side of the cross rail and slide the cross rail down until it rests on the safety lock position closest to the floor. Repeat the procedure for the left columns and cross rail. Stand the assembled columns up in positions indicated on

Four post parking lift
the floor plan.

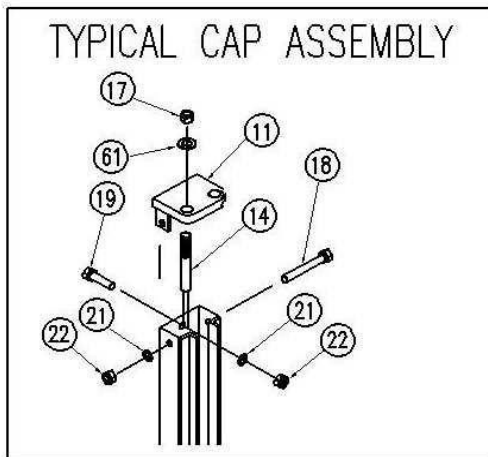

Track Installation

Start the track with the cylinder. This track will be located with the hose Connection facing out toward the column with power unit bracket attached. With an assistant, pick up and place one end of the main side track on the cross rail, and then pick up and place the other end on the opposite cross rail (if you have three assistants, place both ends at the same time). Use a large screwdriver or aligning punch to align the mounting holes in the cross rails with the mounting holes in the track. **Do not leave the tracks unbolted – install the mounting bolts immediately!** Install **M12X100 mounting bolts and M12 washers** thru the ramp brackets and wheel stops. Make sure the bolt head is on the flat side of the bracket. Install the two ramp brackets and two wheel stop with bolts and washers as you secure the main side track to the cross rail. Secure the bolts with M12 washers and nuts placed **hand tight**. Now, install the offside track and again secure with ramp brackets, wheel stops with **M12X100 bolts and nuts**. After both tracks are installed, tighten all bolts M12X100 bolts -torque -60 N-M.

Find the leg caps (**4 each**), **M12X170 bolts (4 each)**, **M16X35 bolts (4 each)**, **M12 nuts (4 each)** and **M12 flat washers (4 each)**, **M16 nuts (4 each)** and **M16 flat washers (4 each)** holes for cable face towards the center of the lift. Secure the leg caps with **M16X35 bolts**. Place the bolts with washers in through channel and secure with washers and nuts on the outside of the leg. Install the **M12X170 bolts** through the leg and top cap. Install from outside of the leg, and secure with a nut on the inside of the leg. Tighten the **M16X35 bolt**. Tighten the

M12X170 bolt to a torque of 60N-M. Do not over tighten the **M12X170 bolt**, as this may warp the column channel and bind the guide blocks.

Insert the bolt end of the cable through the opening in the offside track, then run cable $\frac{1}{4}$ turn or 90 degrees around the pulley on the cross rail. Secure the bolt end to the leg top cap. Place washer and nut on threaded end hand tight.

Safety Latch Linkage Installation: Locate and identify the components needed to install the safety latch linkage rods. Install the spacers from on the straight threaded end of the **M12X1035 bent rod** and the threaded end of the **M12X2285 (for standard type) /2660(for extra long type) straight safety latch linkage rod**.

Install the **M12X1035 bent safety latch linkage rod** into the main side track adjacent to back end of the cylinder (opposite the cylinder rod). Safety latch linkage rod should pass through guide tubes on underside of track.

Four post parking lift

Install the **M12X2285 (for standard type) /2660(for extra long type) straight safety latch linkage rod** into the main side track from the opposite end. The rod should pass through two guides on the underside of the main side track.

Install the 90 fitting w/O-Ring in the base of power unit pump next to the lever operated release valve. **IT IS NOT NECESSARY TO USE TEFLON TAPE ON O-RING FITTING**

Connect the **1800MM hose** to the fitting on the power unit. Attach the other end of the **1800MM hose** to outside fitting in main side track.

Place a funnel into vent cap hole and fill the tank with one of the following fluids: **AW-32** or **ISO-32** hydraulic oil. **Mobile DTE 24, or Texaco HD 32 DO NOT USE DEXRON® IN THIS LIFT!** This tank will hold approximately 10L

Relocating or changing components may cause problems. Each component in the system must be compatible; an undersized or restricted line will cause a drop in pressure. All valve, pump, and hose connections should be sealed and/or capped until just before use. All parts should be supplied from manufacture. Air hoses can be used to clean fittings and other components. However, the air supply must be filtered and dry to prevent contamination. **Most important -cleanliness** -contamination is the most frequent cause of malfunction or failure of hydraulic equipment.

Check Pulley Cover and Lock Collars: Before proceeding, double check to make sure the locking shaft collars for the cross rail cable pulleys are tight and secure. Check the pulley cover (2-RIGHT and 2 LEFT) over the shaft located on the pulley side of each cross rail. CHECK to make sure the pulley and cover are firm against the locking shaft collar already in place. Check the additional lock collar on the outside of the shaft is tight and secure. To prevent personal injury or death, cross rail lock collars must be tight. If they are ever removed -always make sure the locking shaft collars are tight and secure.

Check the cross rail locking assembly before use. Make sure all bolts and collars are tight. The assembly is pre-installed from the factory but parts may come loose during shipping.

After installation is completed, before start up, be sure to inspect and tighten all bolts.

4.2 Operation

To raise the lift

- Position the vehicle at the centre of the platform. Check to make sure that the vehicle is secured.
- Press GREEN button to raise the vehicle
- To rest the lift in standing position at the desired height by releasing GREEN button.
- Always ensure that the lift rests on the safety before any attempt is made to work on or near the vehicle.

To lower the lift

- Be sure the safety area is free of people and objects;
- Raise the lift a little bit by pushing GREEN button to clear off the safety;

Four post parking lift

- Press the release handle and at the same time also press unloading handle on the power unit to lower the lift.
- Lower the lift completely

5. Checking Points before Using

5.1 General Checking Points

Item	Detail	Method	How to avoid
1	Lifting has abnormal sound	visual listen	Lubricating, cleaning replacement
2	the overall appearance of the lift get damage and skew	visual	Maintenance, replacement
3	Wire wheels get deformation and damage	visual	
4	lifting hydraulic system has abnormal sound and oil spills	visual listen	
5	Has trash inside the column	visual	Remove, maintenance and replacement
6	Pull four insurance manipulation handles	visual	Take off guard, adjust steel cable and replace new one
7	Check the chain, the steel cable is normal no damage	Visual	New replacement
8	Check if the connection is loose bolts parts	Visual	Re-strengthening and fixed
9	Check the sprocket, the steel cable wheel whether they are normal no rupture and so on	Operation and visual	New replacement
10	Check the chain, the steel cable wheel if their rotation are normal	Operation and visual	Oiling Lubricating, cleaning, new replacement
11	Check up and down movement of two landslide is normal, comfortable and non-jitter	Operation	Foreign body cleaning, oiling cleaning
12	Check the action of the four insurance block if it's normal and comfortable (with automatic insert action), check the insurance steel cable if it's loose injury	Operation 、 visual、 listen	Foreign body cleaning, oiling cleaning, adjustment or new replacement
13	Whether it is automatically stopped when no-load up to the highest location	Operation	Repair, new replacement

Four post parking lift

14	Check power unit is working properly without abnormal noise	Operation 、 listen	Repair、 new replacement
15	Inspect tanks, oil hoses and connecting joints is normal no leakage	Operation 、 visual	Repair、 new replacement

6. Packing, transport and storage

Only skilled personnel who are familiar with the lift and this manual shall be allowed to carry out packing, lifting, handling, transport and unpacking operations.

90%of components were pre-assembled and packed with blister packing in steel frame for shipment. Power unit was packed together with the lift, and power unit stand was packed and fixed on above lifts.

Lifting and handling. When loading/unloading or transporting the equipment to the site,be sure to use suitable loading (e.g. cranes,trucks) and hoisting means. Be sure also to hoist and transport the components securely so that they cannot drop, taking into consideration of the package's size, weight and centre of gravity and its fragile parts.

Storage and stacking of packaged lifts.

Packaged lifts must be stored in a covered place, out of direct sunlight and at a temperature between-10°C and +40°C.

Delivery and check of packages. When the lift is delivered, check for possible damages due to transport and storage; verify whether the points are included which is specified in the manufacturer's confirmation of order. In case of damage in transit, the customer must immediately inform the carrier of the problem. Packages must be opened carefully, not to cause damage to people (keep a safe distance when opening straps) and parts of the lift (be careful the objects do not drop from the package when opening).

7. Trouble Shooting

Malfunctions	Cause	Solution
Generator does not work.	The power source or power equipment is malfunctioning.	Check up the power fuse, the contact in the junction box of motor, micro switch, and the condition of up button, change the damaged part.
Generator roars and does not work.	a. The top of vane wheel is deformed. b. Capacitor is damaged. c. The voltage is too low. The equipment is used overload.	a. straightening b. replace for new parts c. check up by electric technicians
When the lift is rising,it creeps.	Air has entered the hydraulic system, and the oil box lack oil.	Rise repeatedly to remove the air, and add oil to oil box.

Four post parking lift

Noise is too loud when the lift is working.	The sliding and rotational part lack lubrication and or change the pin roll.	Add lubrication, change the pin roll.
The lift can't rise.	a. There is something wrong with the power unit. b. the button on the power unit is damaged. c. Leakage of oil pipeline	a. Maintain or change for new parts. b. Maintain or change for new parts. c. Clean, tighten and change for new parts.
When lift is rising the speed is slow and heavy.	a. There is not enough hydraulic oil. b. Leakage of oil pipeline c. Oil filter is stopped up.	a. Add hydraulic oil b. Maintenance, tighten and change for new parts. c. Disassemble and clean.
The lift can't drop.	a. The security block is not open. b. Magnets are damaged heavily.	a. Rise first then drop, or maintain. b. Change for new parts.

8. Hydraulic diagram

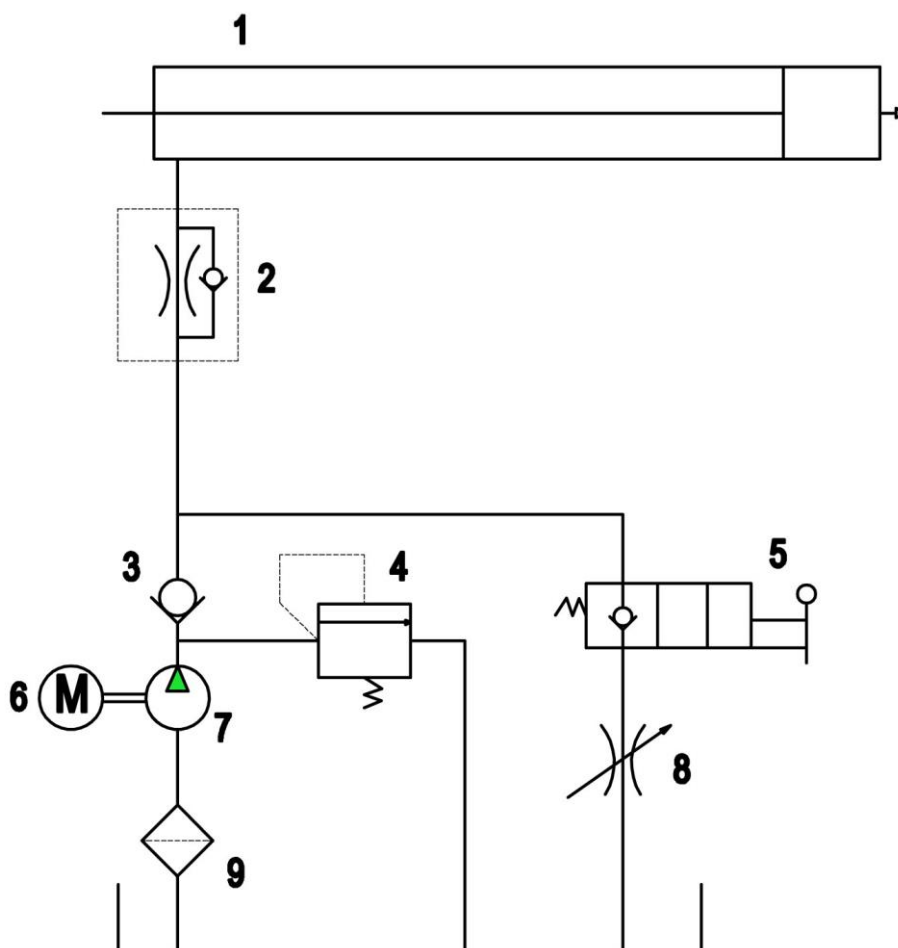

Item	Name	Item	Name	Item	Name
1	cylinder	4	Overflow valve	7	Gear pump
2	One-way overflow valve	5	Unloading valve	8	Adjustable throttling valve
3	One-way valve	6	motor	9	filter

10. spare parts list

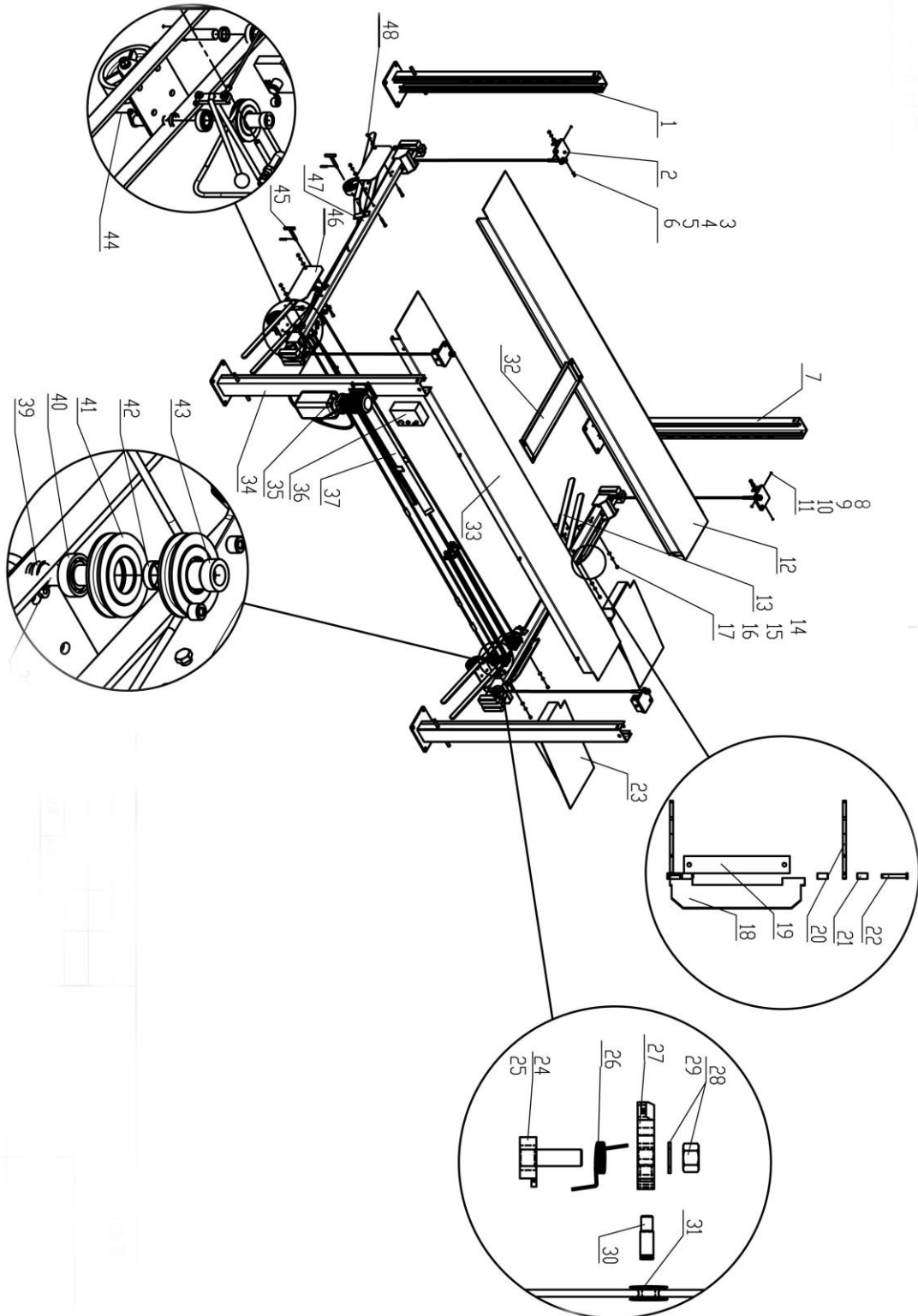

Four post parking lift

27	Roating plate	4
26	Insurance spring	4
25	Base plate	4
24	Roller	4
23	Ramp plate	2
22	Roller	4
21	Roller sleeve	8
20	Parking baffle	4
19	Baffle strip	2
18	Baffle	2
17	M12 hexagonnut	4
16	D12 spring washer	4
15	D12 flat washer	4
14	M12*100hexagon screw	4
13	Moveable frame	4
12	Vice runway	1
11	M16 hexagon nut	4
10	D16 spring washer	4
9	D16 flat washer	4
8	M16*35 hexagon bolts	4
7	Main column	1
6	M12 hexagon nut	4
5	D12 spring washer	4
4	D12 flat washer	4
3	M12*170 hexagon bolts	4
2	Up cap	4
1	Vice column 2	3
No.	Parts name	Quantity

48	M12*80 hexagon screw	4
47	Main beam	1
46	Parking board	2
45	Mobile frame pin	4
44	M6*12 round hexagon screw	4
43	Single wheel on locating sleeve	2
42	Double wheel on locating sleeve	2
41	Double wheel inside locating sleeve	2
40	Deep groove ball bearing	6
39	Single wheel positioning sleeve	6
38	Rope pulley	6
37	Cylinder Travel L2000mm	1
36	Power box	1
35	Hydraulic pump	1
34	Main column 1	1
33	Main runway 1	1
32	Tool box	1
31	Rope trolley	4
30	Pin	4
29	M20 nut	4
28	D20 flat washer	4
No.	Parts name	Quantity